

# Automatic Viscosity Control And Measurement System

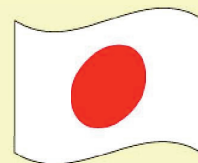

**JAPAN  
QUALITY**

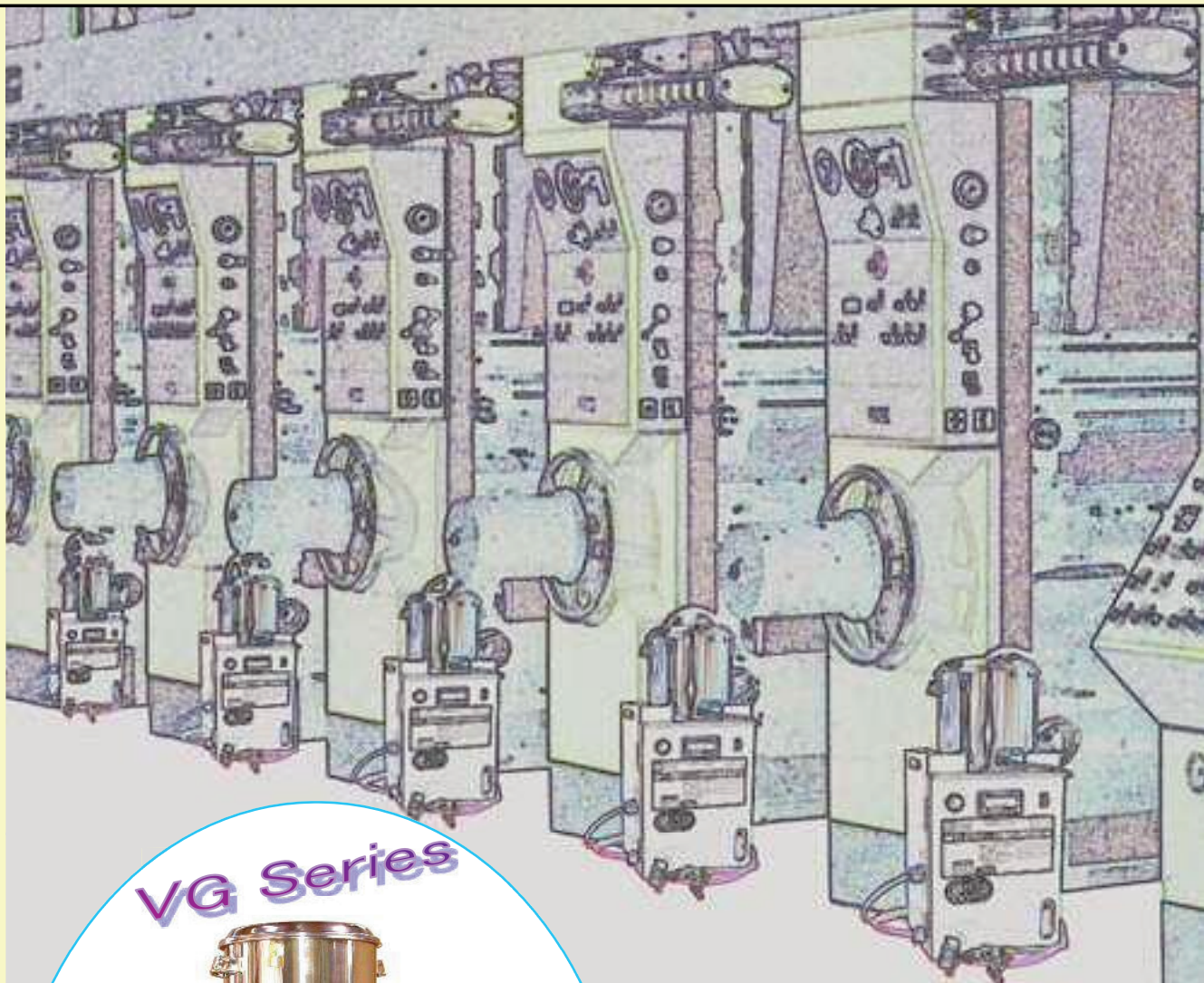

*VG Series*



**MEISEI IVC**

*MEISEI Corporation*

Phone: +81-574-65-1666

Fax: +81-574-65-1667

E-mail [info@meiseivc.co.jp](mailto:info@meiseivc.co.jp)

URL <http://www.meiseivc.co.jp/>

JAPAN



**IN LINE**

# Automatic Viscosity Control For Inks, Coatings and Adhesives

*The best selling viscosity control and measurement system for the past 30years. Meisei has more than 80%of the Japanese market share. More than 19,000 systems have been sold to coating, gravure and flexo companies in Japan, and 19 countries.*

*Meisei's excellent customer support provides impeccable service after the sale ! Demo-device available on request.*

**THE MARKET LEADER!**



## ◆ Functions and Features ◆

- ① Single unit performs four functions: ink circulation, ink agitating, viscosity measurement and viscosity control.
- ② Improves product quality and color consistency. Decreases losses and customer claims. -Guaranteed !
- ③ By providing uniform viscosity, waste is minimized and ink consumption is reduced by 15 ~ 20%
- ④ Non leak and safety by pneumatic diaphragm.
- ⑤ Easy to wash by only half a gal of solvent, takes 3 minutes.
- ⑥ Automatic oil lubrication and recycling system extends pump life by 3 times longer.
- ⑦ Kink-free, solvent resistant hoses are soft and easy to handle.
- ⑧ Compact and lightweight, the system is easy to move, setup and operate.
- ⑨ Make operators free to adjust viscosity level, Operator can now devote their attention to other matters.

**[VG-10 Type]**

## ◆ Viscosity display ◆



CHANGE button

ALARM SET POINT

- ★ The controller LED display is large, bright and easy to read.
- ★ Viscosity is displayed in cup-seconds.

## What's NEW

- ① **Stainless steel box** ..... Easy care
- ② **Sealed electric room** ..... Safe maintenance
- ③ **Unique top board** ..... No solvent invasion
- ④ **Exhaust cleaner** ..... Clean exhaust air and less noise
- ⑤ **Digital pressure switch** ... More accurate and less noise
- ⑥ **Interlock system** ..... Pump works only while main switch is ON
- ⑦ **Compact box** .. Approximately 15% less volume compared with GP-15
- ⑧ **Detachable backboard** ... Easy maintenance
- ⑨ **Demountable pump** ..... Easy maintenance

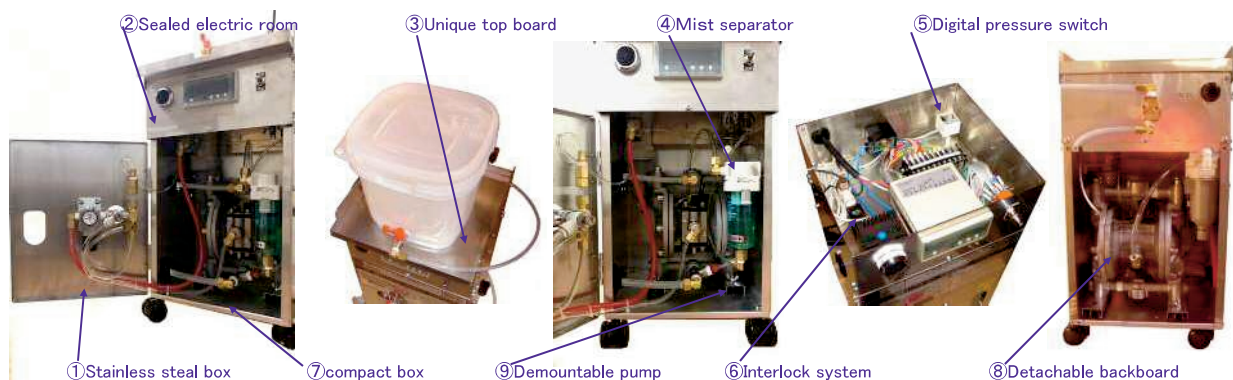

## ◆ PRINCIPLE

These viscosity controller systems are controlled by sensing viscosity through the loads placed on the diaphragm pump.

(The evaporation of solvent in the tank causes the liquid viscosity is thickening.

As the liquid viscosity thickens, the load on the pump is also increased. Then the pump cycle is getting slow.

As the liquid viscosity thins, the load on the pump is also decreased. Then the pump cycle is getting fast.)

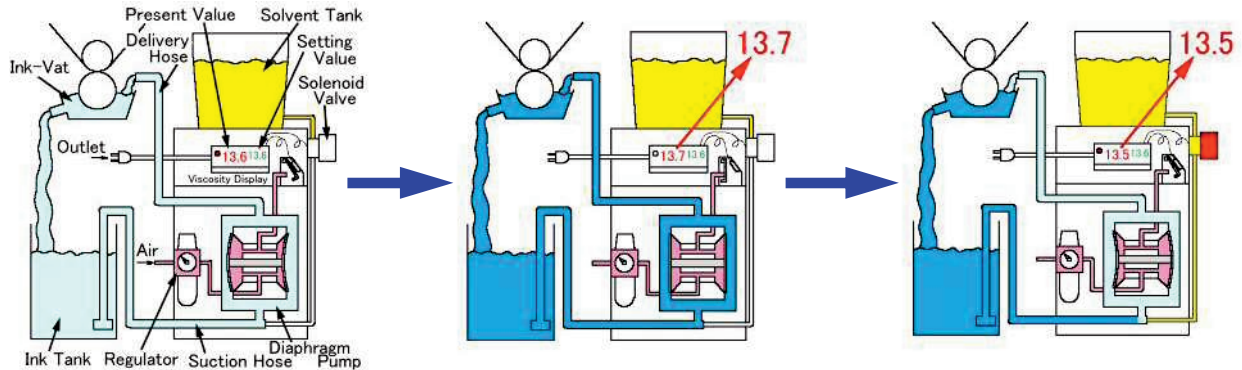

- ① The system detects the diaphragm pump pulse times that the liquid is circulating through. Viscosity Present Value is displayed. Set up this value as the upper limit.
- ⑤ The Viscosity Present Value returns the beginning value.

- ② The liquid viscosity thickens and the load on the diaphragm pump is increased. Then Viscosity Present Value becomes higher.

- ③ The solenoid valve will open and feed the solvent after it catches the electric signal from the sensor.
- ④ The sensor detects that Viscosity Present Value is getting small by pump air exhaust.

## ◆ EXAMPLES OF INSTALLATION

We are explaining how to install in case of using Inks by the following illustrations. But if you would like to use Adhesives, Coatings or Varnish, you can install in the same condition as inks.

① Direct circulation

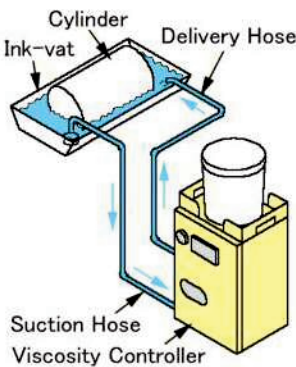

② Circulation through ink-tank

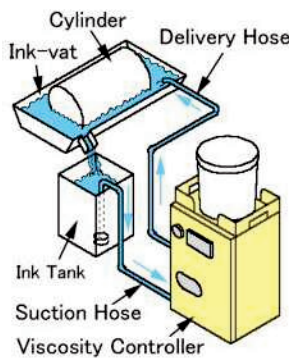

③ Circulation through ink-tank with using circulating pump

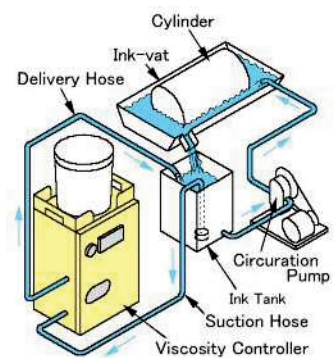

④ Circulation through ink-tank with circulating pump for Roll coater

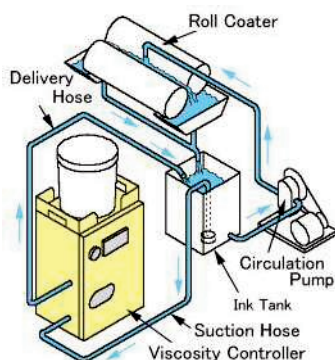

⑤ Circulation through ink-tank for Ink chamber

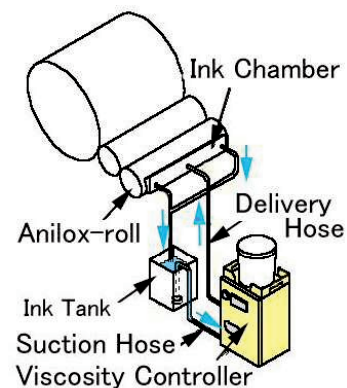

◆SPEC.

Model No.	VG-10-S11	VG-15-S11
Appearance	box type of stainless steel mono-block	box type of stainless steel mono-block
Dimension	260mm x 230mm x 740mmH	260mm x 230mm x 740mmH
Net weight	15 kg	16 kg
Control range	13~30 sec ( Rigosha Zahn Cup No.3) 30~100 cps	13~30 sec ( Rigosha Zahn Cup No.3) 30~100 cps.
Solvent tank	11 liters made of Stainless Steel	11 liters made of Stainless Steel
Suction hose	O/D 12mm x I/D 8mm x 2,500mmL	O/D 16mm x I/D 11mm x 2,500mmL
Delivery hose	O/D 10mm x I/D 6.5mm x 2,500mmL	O/D 12mm x I/D 8mm x 2,500mmL
Circulation volume	1.8~3.9 liters/min	3.2~8.8 liters/min
Air consumption	40 liters/min	90 liters/min
Working pressure	0.3MPa	0.3MPa
Working voltage	AC100-120V/40W ( Option 200-240V)	AC100-120V/40W ( Option 200-240V)
Max. volume of Sub-tank	10~20 liters	21~50 liters

【Notice】

The liquid circulating quantity and air consumption stand for the maximum quantities while Viscosity controller is operating. Supply the compressed air more than 1.5 times as quantity as air consumption.



【VG-10 Type】



【VG-15 Type】

◆MODEL SELECTION

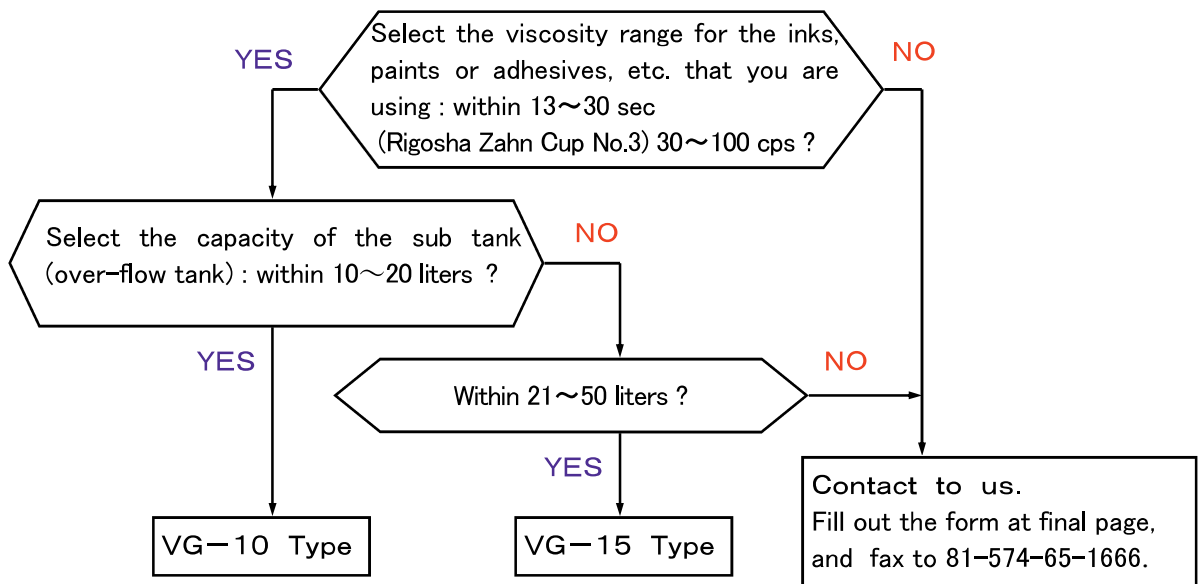

◆OTHERS

①VA-10-M Type

Controlled viscosity range: 100~300 CPS  
 Solenoid valve for solvent supply is made use of flameproof type of explosion-protected construction.  
 Solvent tank is made of stainless steel, capacity : 8 liters.



②VS-15 Type

Separated steel boxes, controller and pump unit.  
 Steel box for pump unit can be set up at even dangerous area, but steel box for controller cannot be set up dangerous area.

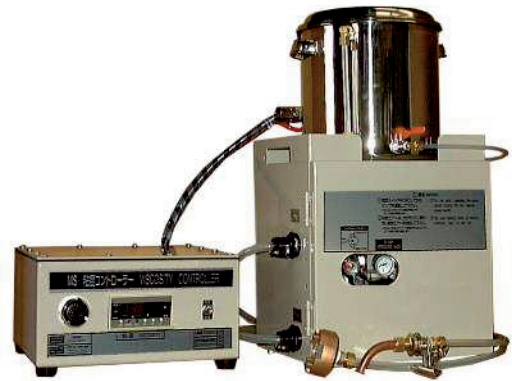

③VG-10-A Type

The equalizer can defuse the exhaust pulsation.



④VG-10-FH Type

The dusts and dregs in the ink are filtered and eliminated by the cartridge filter.



⑤VG-10-TD Type

The ink temperature is displayed.



**NEW**

⑥VG-10-W Type

Hybrid Automatic Washing System

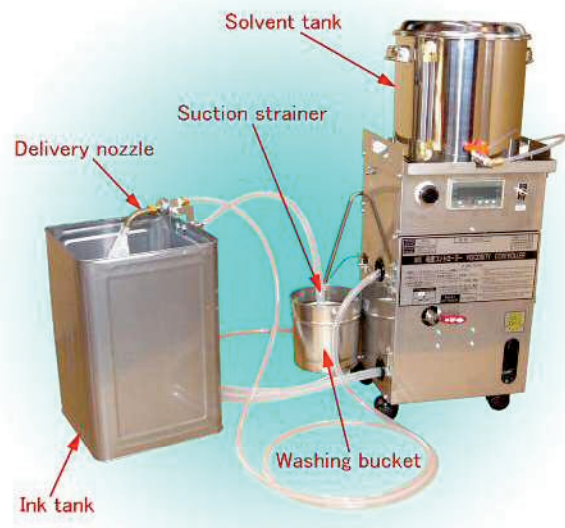

◆RELATED EQUIPMENTS

①Moisture eliminator in the compressed air.

**M-Drain**

99.5% of the moisture in the compressed air can be eliminated.



②Double structure hose.

Super flexible, kink-free and solvent-proof  
Size: External diameter X Internal diameter  
10mm X 6.5mm, 12mm X 8mm  
16mm X 11mm, 21mm X 15mm  
25mm X 19mm

【Bending】 【Return to former state】



③Special lubricating oil for Viscosity controller

**MEISEI Super 1000**

The durability of the diaphragm pump is improved.  
Capacity: 4 liters



④Pneumatic driving agitator.

**VF-03 type**

Ink in the tank is agitated. Available for drum tank.



⑤Circulating pump.

**SP -E type**

The liquid is suctioned, delivered and circulated by this pump.



⑥MEISEI cup (measuring cup of viscosity).

**ZC-2·3·4·5·6·7 type**

Easy to measure the viscosity.

**NEW**



⑦Pouring nozzle.

**SN-40 / SN-50 type**

These pouring nozzles are used to fix at the mouth of pail can.  
40mm dia. and 50mm dia. for the pouring mouth are available.



## MS Filter

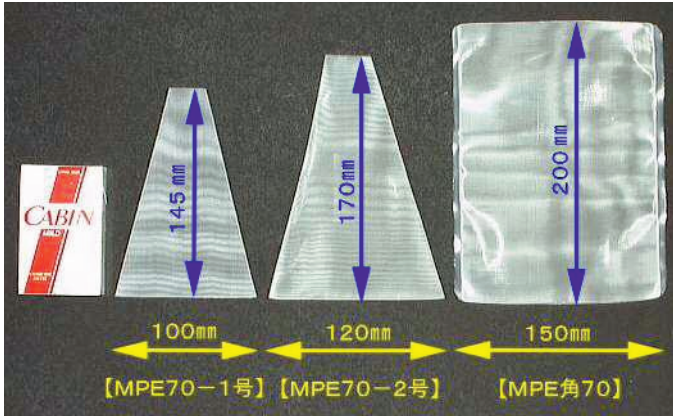

Filter No.	Mesh count	Aperture size (mm)	Width (mm)	Height (mm)
MPE45-1	45	0.34	100	145
MPE70-1	70	0.21		
MPE85-1	85	0.18		
MPE100-1	100	0.15		
MPE140-1	140	0.11		
MPE45-2	45	0.34	120	170
MPE70-2	70	0.21		
MPE85-2	85	0.18		
MPE100-2	100	0.15		
MPE140-2	140	0.11		
MPE-kaku45	45	0.34	150	200
MPE-kaku70	70	0.21		
MPE-kaku85	85	0.18		
MPE-kaku100	100	0.15		
MPE-kaku140	140	0.11		

### 【Features】

- ① Solvent-proof net is processed like a bag.
- ② Filter mesh has the mesh count No. 45, 70, 85, 100 and 140.
- ③ Filter mesh has trapezoid shape No. 1 and No. 2, also rectangular shape. In case of used at the pump has big exhausting ink quantity and many dusts are contained, No.2 or rectangular shape is used.
- ④ In case of Gravure printing, No. MPE70-1 is usually used. The magnet in the filter eliminates iron powder and prevents to produce the printing defective.
- ⑤ 1 set: 500 pcs. (per a unit)

【Reference】 The aperture size of nylon stockings is between 0.5mm and 0.8mm. Sample is MPE70.

## Ink Tank Filter: SPE (Bag-shape Filter)



### 【Features】

- ① Anti-solvent bag-shape filter.
- ② Filter mesh has the mesh count No. 70 and 100.
- ③ Using special shaped holder, this can be used for ink tank up to 300 width.
- ④ Special shaped holder is designed to fit ink tank perfectly.
- ⑤ This filter is washable and can be reused many times to save the cost.
- ⑥ 1 set : 50 pieces.

## TG Filter :TG (Roll Filer)

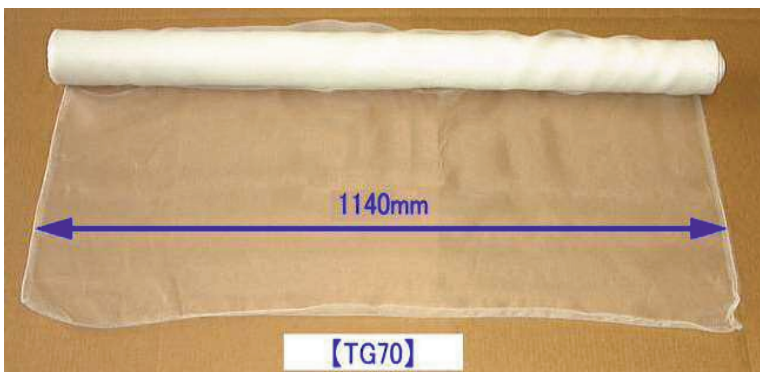

### 【Features】

- ① Anti-solvent sheet filter (1 roll: 50m)
- ② To save the cost, cutting it out just as needed.

Filter No.	Mesh	Aperture (mm)	Width (mm)
TG70	70	0.28	1140
TG100	100	0.19	1140

◆SPEC. CHECKING LIST

*Demo-device available on request.*

DATE: \_\_\_\_\_.

Company name:		Name & title	
Address: City, State: Zip:		Phone:	
		Fax:	
		E-mail:	
Type of process at this location (Check all that apply): <input type="checkbox"/> Flexography <input type="checkbox"/> Gravure <input type="checkbox"/> Coating <input type="checkbox"/> Laminating <input type="checkbox"/> Marking <input type="checkbox"/> Other(                    )			
The name of liquid which is used: <input type="checkbox"/> Ink <input type="checkbox"/> Paint <input type="checkbox"/> Adhesive			
Base: <input type="checkbox"/> Solvent or <input type="checkbox"/> Water			
The name of material (Printed matter) which is used printing or coating: <input type="checkbox"/> Paper <input type="checkbox"/> Film <input type="checkbox"/> Metal <input type="checkbox"/> Wood <input type="checkbox"/> Others(                    )			
Your products:			
Number of lines and colors: (    ) colors x (    ) lines, (    ) colors x (    ) lines, (    ) colors x (    ) lines			
Ink consumption:            liters/hour            liters/day            gal/hour            gal/day			
Voltage: system voltage is <input type="checkbox"/> 100v <input type="checkbox"/> 120v <input type="checkbox"/> 220v <input type="checkbox"/> 240v <input type="checkbox"/> Others(                    v)			
Select suitable installation style from the examples on page 3: <input type="checkbox"/> No. 1 <input type="checkbox"/> No. 2 <input type="checkbox"/> No. 3 <input type="checkbox"/> No. 4 <input type="checkbox"/> No. 5 <input type="checkbox"/> Others(                    )			
Ink vat capacity:            liters (            gal)			
Ink tank capacity (if applicable):            liters (            gal)			
Range of ink viscosity cup: from            Sec to            Sec.			
Manufacturer's name of measurement cup & Number:			
Cup/Sec of solvent:            Sec. (measured by the above cup)			
Circulation pump: <input type="checkbox"/> Equipped <input type="checkbox"/> Not equipped			
Pump circulation volume:            liters/min.            gal/min			
Mixer: <input type="checkbox"/> Equipped <input type="checkbox"/> Not equipped			
Adaptable Model (This space is used by Meisei):			

**MEISEI Corporation**

762-8, Ima Aza Tatsuno, Kani City, Gifu Pref.,  
Japan 509-0246

Phone: +81-574-65-1666 Fax: +81-574-65-1667

E-Mail: info@meiseivc.co.jp

http://www.meiseivc.co.jp/



KIGENG TRADING CO., LTD.

基源貿易有限公司

新北市中和區中山路2段411號6樓

6F., No. 405, Sec. 2, Jungshan Rd., Junghe Dist, New Taipei City, Taiwan 235, R.O.C.

TEL: 886-2-2225-7688 FAX: 886-2-2225-1978

URL: http://www.kigeng.com.tw

E-mail: sales@kigeng.com.tw